

REV	DESCRIPTION	DATE	BY
A	NEW DRAWING	11/15/06	H.N.

F7888

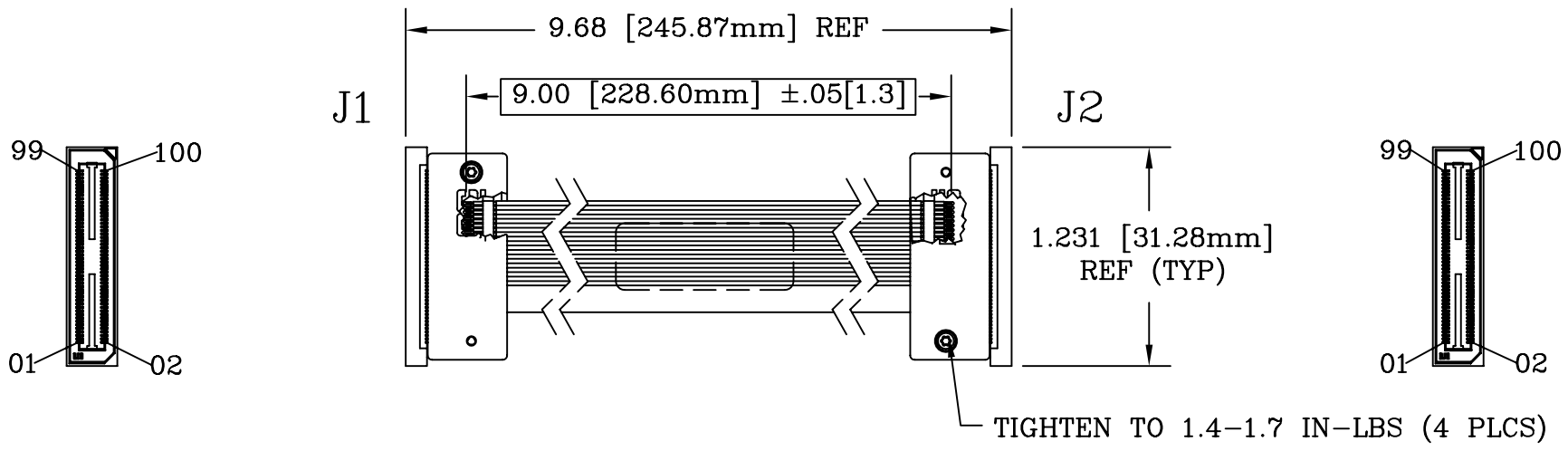
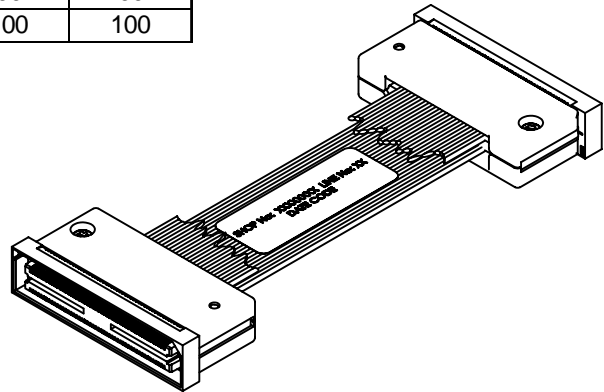
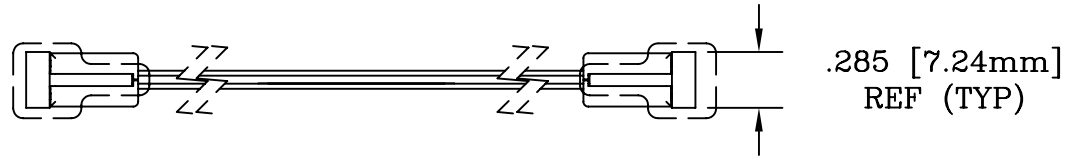

TABLE 1
SIGNAL MAPPING

J1 POS	J2 POS
1	1
2	2
3	3
4	4
5	5
.....
96	96
97	97
98	98
99	99
100	100



UNLESS OTHERWISE SPECIFIED:
DIMENSIONS ARE IN INCHES
(ALTERNATE) DIMENSIONS ARE IN mm
TOLERANCES:
ANGLES: ±
FRACTIONS: ±1/64
DECIMALS:
.XX ±.010
.XXX ±.005
.XXXX ±.0005

ALL DIMENSIONS ARE IN INCHES UNLESS OTHERWISE SPECIFIED

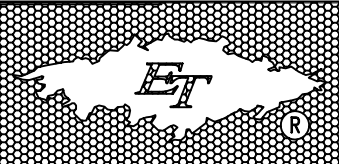

Emulation Technology, Inc.
— VLSI and SMT ADAPTERS and ACCESSORIES —
2344 Walsh Avenue, Bldg.F Santa Clara, Ca 95051
TEL:(408)982-0660 FAX:(408)982-0664

SHEET: 1 OF 1	DATE: 11/15/06	REVISION: A	ASSEMBLY DRAWING
CHECKED: Perry Munroe	DRAWN: Huy Nguyen	ITEM: SAM100CABLEFF9	
Scale N/A DO NOT SCALE DRAWING			DESCRIPTION: SAM-100-CABLE-FF-9